

Q80A

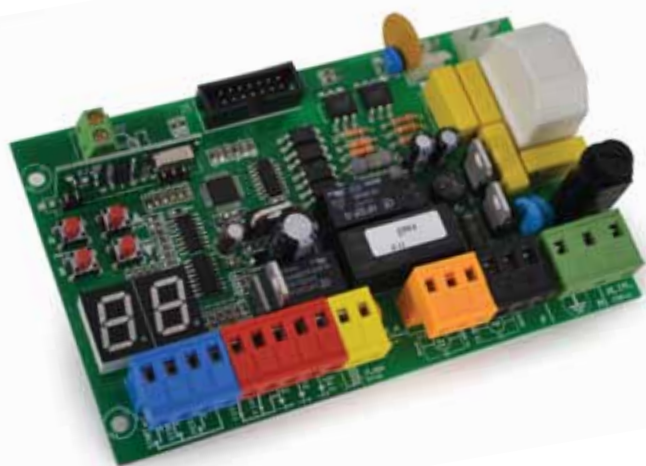

Multi-function control panel for double/single swing gate - 230Vac

- Programming display
- Electronic adjustment of each motor's working time
- Automatic programming procedure with obstacle detection (anti-crushing function) or step-by-step programming procedure with electronic adjustment of power and deceleration for each motor.
- "Quick closing" function
- Pedestrian Opening function
- Electronic adjustment of the delay between leaves for opening and closing.
- Multi-Occupation function.
- Pre-Blinking function.
- Additional radio channel (optional module)
- Terminal for electric lock (optional module)
- Reversing stroke and lock pulse functions for electric lock.
- Built-in radio receiver 433,92MHz (64 codes) suitable for standard fix-code transmitters or rolling-code transmitters.
- Terminal for safety edge 8K2 type
- Fault Diagnostic with display messages

TECHNICAL FEATURES

Item code	PQ80A, PQ80A1D
Control Panel Dimensions	137 x 84 x 37 mm
Box dimensions	220 x 290 x 90 mm
Control Panel Weight	160 g
Main Power	230 ~ 50-60Hz
Main Power Tolerance	-10% +20%
Transformer	230/21Vac – 15VA
Main Fuse	5 A
Rated power input	600 W
Rated current	3.5 A
Current in stand-by mode	30 Ma
Blinker power supply	24 Vac, max 20 W
Accessories power supply	24 Vdc, max 5 W
Electric Lock power suppli	12 Vdc, max 15 W
Box dimensions	220 x295x95mm
Working temperature	-20 +50 °C
Protection Level (with box)	IP55

Index

1.	WARNINGS	<i>pag. 02</i>
2.	WIRING DIAGRAM AND COMPONENTS	<i>pag. 03</i>
3.	ELECTRIC WIRINGS	<i>pag. 04</i>
3.1	MOTORS wiring	<i>pag. 06</i>
3.2	MAINS POWER wiring	<i>pag. 07</i>
3.3	START controls wiring	<i>pag. 07</i>
3.3.1	TIMER wiring	
3.3.2	KEY-SWITCH wiring	
3.4	PEDESTRIAN START controls wiring	<i>pag. 07</i>
3.5	STOP push-button wiring	<i>pag. 08</i>
3.6	PHOTOCELLS wiring	<i>pag. 08</i>
3.6.1	CLOSING Photocells wiring	
3.6.2	OPENING Photocells wiring	
3.7	SAFETY EDGE wiring	<i>pag. 09</i>
3.7.1	CLOSING Safety Edge	
3.7.2	OPENING Safety Edge	
3.8	BLINKER wiring	<i>pag. 10</i>
3.9	ELECTRIC-LOCK wiring	<i>pag. 10</i>
3.10	AUX/2nd RADIO CHANNEL module	<i>pag. 10</i>
3.10.1	2nd RADIO CHANNEL settings	<i>pag. 11</i>
3.10.2	CONTROL LIGHT settings	
3.10.3	COURTESY LIGHT settings	
3.10.4	MAGNETIC LOCK mode	
4.	PROGRAMMING	<i>pag. 12</i>
4.1	Menu RADIO	<i>pag. 12</i>
4.2	PROGRAMMING menu	<i>pag. 14</i>
4.2.1	Selecting the PROGRAMMING MODE	
AUTOMATIC programming mode, with OBSTACLE DETECTION		
SEQUENTIAL programming mode	<i>pag. 15</i>	
4.2.2	Restoring DEFAULT SETTINGS	<i>pag. 16</i>
RAM opener default settings		
ARTICULATED ARM opener default settings		
WHEEL-DRIVEN opener default settings		
4.3	FORCE menu	<i>pag. 17</i>
TORQUE/POWER adjustment - MOTOR1		
TORQUE/POWER adjustment - MOTOR 2		
OBSTACLE DETECTION adjustment - MOTOR1	<i>pag. 18</i>	
OBSTACLE DETECTION adjustment - MOTOR 2		
4.4	FUNCTIONS menu	<i>pag. 19</i>
MULTI-OCCUPATION		
PRE-BLINKIN		
DECELERATION	<i>pag. 20</i>	
PHOTOCELLS TEST		
REVERSING STROKE		
LOCK PULSE	<i>pag. 21</i>	
START-UP / SOFT START		
QUICK CLOSING		
SINGLE LEAF	<i>pag. 22</i>	
SEPARATE PUSH-BUTTONS		
MOTORS TEST		
FINAL RELEASE closing	<i>pag. 23</i>	
FINAL RELEASE opening		
FLASHING LIGHT mode		
4.5	TIMES menu	<i>pag. 24</i>
OPENING DELAY between leafs		
CLOSING DELAY between leafs		
AUTOMATIC CLOSING pause time	<i>pag. 25</i>	
PEDESTRIAN CLOSING pause time		
OPERATING time		
DECELERATION time	<i>pag. 26</i>	
PEDESTRIAN OPENING time	<i>pag. 27</i>	
4.6	ACCESSORIES menu	<i>pag. 28</i>
EMERGENCY STOP terminals		
CLOSING PHOTOCELLS terminals		
OPENING PHOTOCELLS/SAFETY EDGE terminals		
4.7	CYCLE COUNTING MENU	<i>pag. 29</i>
5.	TROUBLE-SHOOTING	<i>pag. 30</i>
6.	BOX Installation	<i>pag. 31</i>
7.	DISPOSAL	<i>pag. 31</i>
ANNEX 1	Table for PROGRAMMING	
ANNEX 2	CE Declaration	

1. WARNINGS

WARNING: This manual contains important information concerning personal safety. An incorrect installation or an improper use may lead to severe injuries.

Read carefully and pay particular attention to the safety sections marked by the symbol .

Store this manual safely for future use.

 Do not allow children or pets near your gate. Never let children operate or play with gate controls. Keep the remote controls away from children and unauthorised users.

 All wirings or operations on the control panel must be performed with the control panel disconnected from the power supply.

 Connect the control panel only to a power supply line equipped with safety grounding system.

Wiring, settings and commissioning of this control board must be carried out by qualified and experienced personnel only. The installation has to comply to laws and regulations in force, with particular reference to EN 12445 provisions.

This appliance is only to be used with the power supply unit provided with the appliance.

Means for disconnections must be incorporated in the fixed wiring in accordance with the wiring rules and wiring diagram (please see paragraph 3).

When operating a biased-off switch, make sure that other persons are kept away.

**Frequently examine the installation for signs of wear or damage to cables.
Do not use if repair or adjustment is needed.**

This panel can control double leaf gate as well as single leaf gate.

**In case of single leaf gates,
please pay particular attention to paragraphs marked by this symbol:**





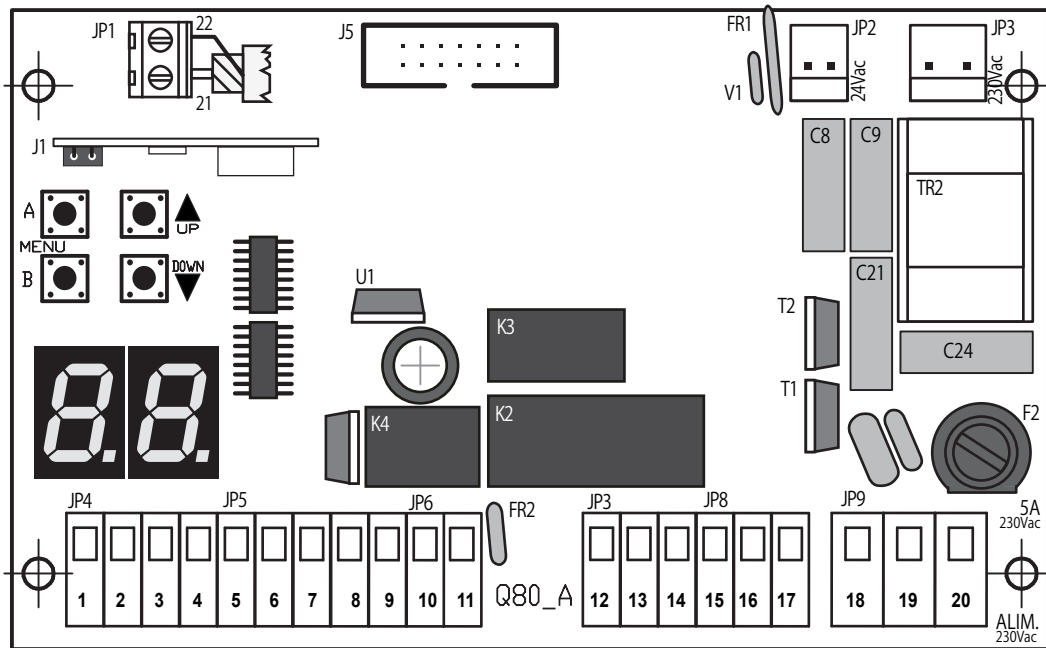

2. WIRING DIAGRAM and COMPONENTS



- DISPLAY** = segments display
J1 = radio module
J5 = plug for optional modules
F2 = 230V fuse 5A
FR1 = 24V fuse 1.6A (self-restorable)
FR2 = 24V fuse 0.6A (self-restorable)
V1 = secondary varistor
K2/K3 = motors relay
K4 = blinker relay
TR2 = filter
- JP1** = AERIAL terminal block
JP2 = secondary transformer plug 24Vac
JP3 = main transformer plug 230Vac
JP4 = CONTROLS terminal block
JP5 = PHOTOCELLS terminal block
JP6 = BLINKER terminal block
JP7 = Motor 1 (M1) terminal block
JP8 = Motor 2 (M2) terminal block
JP9 = 230V MAIN power/earth terminal block

Display BUTTONS Legend

A 	ENTER
B 	EXIT
	INCREASE or START command (when not programming)
	DECREASE or PEDESTRIAN START command (when not programming)

3. ELECTRIC WIRINGS

WIRING Diagram for **230Vac** motor

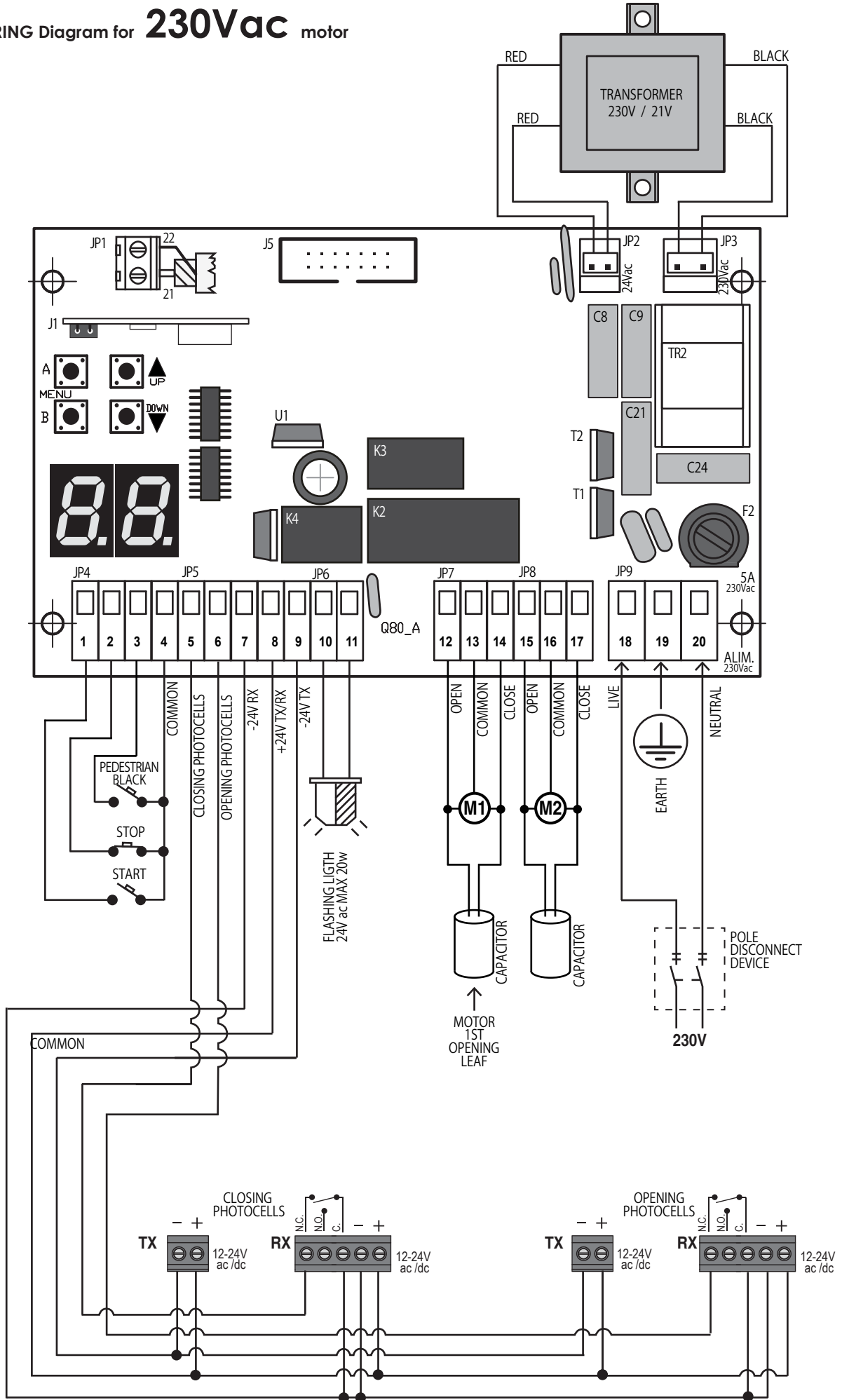

JP1 = AERIAL terminal block

- 21 aerial cable (SIGNAL)
- 22 aerial cable (EARTH)

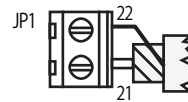

JP2 = TRANSFORMER secondary plug 24Vac (red wires)



JP3 = TRANSFORMER main plug 230Vac (black wires)

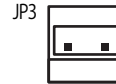

JP4 = CONTROLS terminal block

- 1 START command (N.O. contact)
- 2 STOP command (N.C. contact)
- 3 PEDESTRIAN START command (N.O. contact)
- 4 NEUTRAL for controls

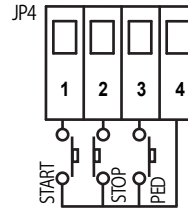

JP5 = PHOTOCELLS and SAFETY DEVICES

- 5 CLOSING PHOTOCELLS terminal (N.C. contact)
- 6 OPENING PHOTOCELLS terminal (N.C. contact)
- 7 Photocells RECEIVER power supply -24V
- 8 Photocells RECEIVER/TRANSMITTER
- 9 Photocell TRANSMITTER power supply -24V

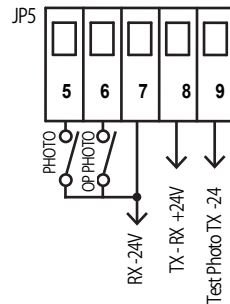

JP6 = BLINKER terminal block

- 10 BLINKER power supply 24Vac
- 11 BLINKER power supply 24Vac

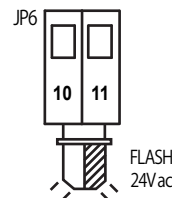

JP7 = MOTOR 1 (M1) terminal block

- 12 OPENING
 - 13 NEUTRAL
 - 14 CLOSING
- } terminal MOTOR M1

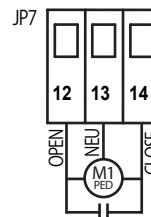

JP8 = MOTOR 2 (M2) terminal block

- 15 OPENING
 - 16 NEUTRAL
 - 17 CLOSING
- } terminal MOTOR M2

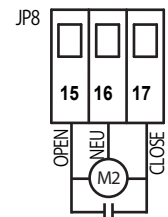

JP9 = 230V MAIN POWER/EARTH terminal block

Pole disconnect means must be incorporated in the fixed wiring to the control panel

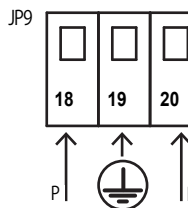

J5 = plug for optional modules

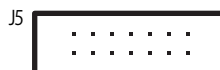

3.1 MOTORS wiring

- M1** motor 1 → first opening and **last closing leaf**.
- M2** motor 2 → last opening and **first closing leaf**.

Wire motor 1 **M1** to terminals **12 - 13 - 14** on **JP7** terminal block.
 Wire motor 2 **M2** to terminals **15 - 16 - 17** on **JP8** terminal block.



In case of single leaf gate, please wire the motor to **12 - 13 - 14** terminals on terminal block **JP7**.

Please see the following wiring scheme for your automation model as the Open/Close connections may vary:

		AUTOMATION MODEL		
		Traditional Ram	Slimline Ram	Underground motor
GATE TYPE		Articulated ram motor		Wheel-driven motor
Left leaf 1st opening (M1)		<p>JP7: 12 (Brown), 13 (Grey-Blue), 14 (Black) JP8: 15 (Black), 16 (Grey-Blue), 17 (Brown) M1, M2, CAPACITOR</p>	<p>JP7: 12 (Brown), 13 (Grey-Blue), 14 (Black) JP8: 15 (Brown), 16 (Grey-Blue), 17 (Black) M1, M2, CAPACITOR</p>	<p>JP7: 12 (Black), 13 (Grey-Blue), 14 (Brown) JP8: 15 (Brown), 16 (Grey-Blue), 17 (Black) M1, M2, CAPACITOR</p>
Right leaf 1st opening (M1)		<p>JP7: 12 (Black), 13 (Grey-Blue), 14 (Brown) JP8: 15 (Brown), 16 (Grey-Blue), 17 (Black) M1, M2, CAPACITOR</p>	<p>JP7: 12 (Brown), 13 (Grey-Blue), 14 (Black) JP8: 15 (Brown), 16 (Grey-Blue), 17 (Black) M1, M2, CAPACITOR</p>	<p>JP7: 12 (Marrone), 13 (Grey-Blue), 14 (Black) JP8: 15 (Black), 16 (Grey-Blue), 17 (Brown) M1, M2, CAPACITOR</p>
Left leaf (M1)		<p>JP7: 12 (Brown), 13 (Grey-Blue), 14 (Black) M1, CAPACITOR</p>	<p>JP7: 12 (Brown), 13 (Grey-Blue), 14 (Black) M1, CAPACITOR</p>	<p>JP7: 12 (Black), 13 (Grey-Blue), 14 (Brown) M1, CAPACITOR</p>
Right leaf (M1)		<p>JP7: 12 (Black), 13 (Grey-Blue), 14 (Brown) M1, CAPACITOR</p>	<p>JP7: 12 (Brown), 13 (Grey-Blue), 14 (Black) M1, CAPACITOR</p>	<p>JP7: 12 (Brown), 13 (Grey-Blue), 14 (Black) M1, CAPACITOR</p>

3.2 MAIN POWER wiring

Pole disconnect means must be incorporated according to current rating.

Connect 230V power to **18 - 19 - 20** terminals on **JP9** terminal block, paying attention to respect polarity (18 PHASE- 20 NEUTRAL).

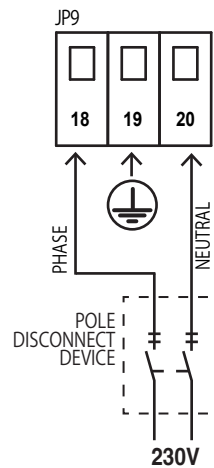

3.3 START controls wiring

Wire the START control/push-button to **1** and **4** terminals on **JP4** terminal block (N.O. contact).

Additional START controls/push-buttons can be wired in **parallel** (N.O. contact).

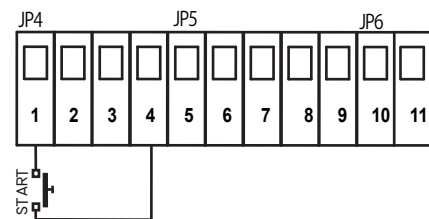

3.3.1 TIMER (for permanent opening command) wiring

Wire the TIMER to **1** and **4** terminals on **JP4** terminal block (N.O. contact).

NOTICE:

IF WIRING A TIMER-CLOCK YOU MUST SET MULTI-OCCUPATION FUNCTION HI ON

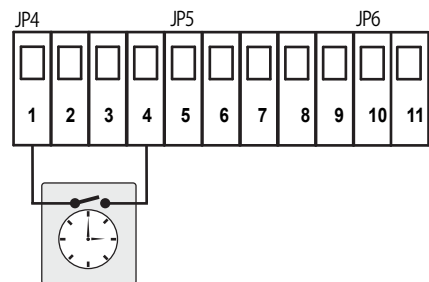

3.3.2 KEY-SWITCH wiring

Wire the KEY-SWITCH to **1** and **4** terminals on **JP4** terminal block (N.O. contact).

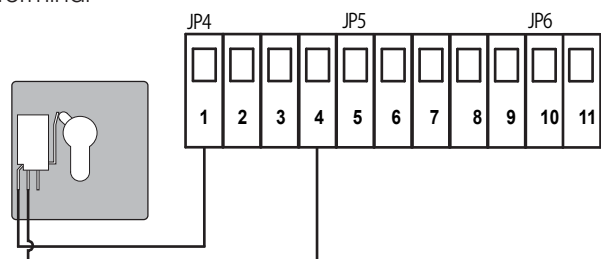

3.4 PEDESTRIAN START controls wiring

Wire the PEDESTRIAN START control/push-button to **3** and **4** terminals on **JP4** terminal block (N.O. contact).

Additional PEDESTRIAN START controls/push-buttons can be wired in parallel (N.O. contact)

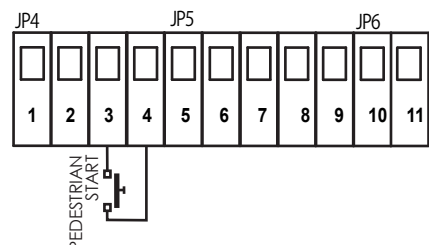

3.5 STOP push-button wiring

Wire the STOP push-button to **2** and **4** terminals on **JP4** terminal block.
Additional STOP controls/push-buttons can be wired in parallel (N.C. contact)

⚠ The wiring of an emergency stop push-button is highly recommended for the safety of people and objects.

Note: Should you need to temporary exclude the STOP connections, please set **P1** parameter in the ACCESSORIES menu to **00**=DISABLED.

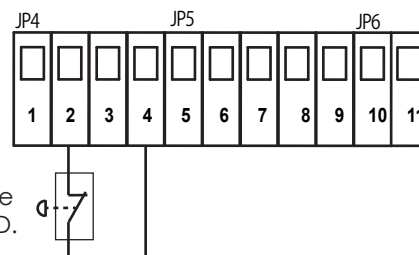

3.6 PHOTOCELLS wiring

3.6.1 CLOSING Photocells

Power the CLOSING PHOTOCELLS wiring them to terminals **7 - 8 - 9** on **JP5** terminal block.

Wire the N.C. contact of the photocells to terminals **5 - 7** on **JP5** terminal block.

The closing photocells will behave as follows:

- If an obstacle interrupts the photocell beam when the gate is closing, the automation **STOPS** and **REVERSES** in about 1.5 seconds.
- An obstacle detected by the photocells when the gate is OPENING does not cause any effect.

Additional sets of CLOSING PHOTOCELLS can be wired in series (N.C. contact).

⚠ For safety reasons at least one set of photocells must be installed to protect the CLOSING area of the gate.

Note: Should you need to temporary exclude the CLOSING PHOTOCELLS connections, please set **P2** parameter in the ACCESSORIES menu to **00**=DISABLED.

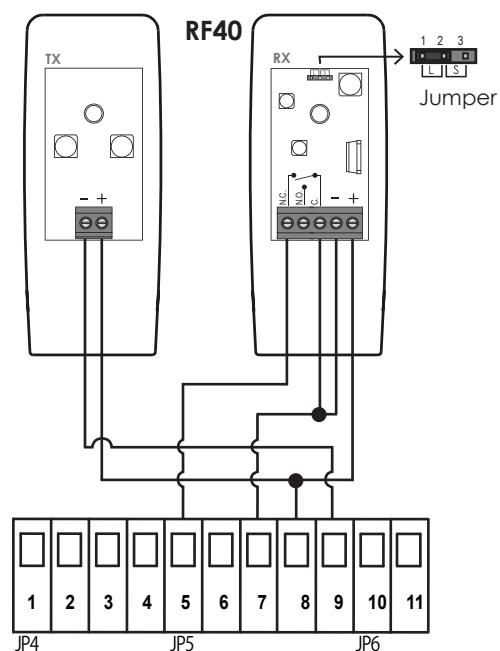

3.6.2 OPENING Photocells

Power the OPENING PHOTOCELLS wiring them to terminals **7 - 8 - 9** on **JP5** terminal block.

Wire the N.C. contact of the photocells to terminals **6 - 7** on **JP5** terminal block.

The opening photocells will behave as follows:

- If an obstacle interrupts the photocell beam when gate is opening, the automation **STOPS**. Once the obstacle has been removed the gate CONTINUES to open.

Additional sets of OPENING PHOTOCELLS can be wired in series (N.C. contact).

⚠ For safety reasons at least one set of photocells must be installed to protect the OPENING area of the gate.

Note: Should you need to temporary exclude the OPENING PHOTOCELLS connections, please set **P3** parameter in the ACCESSORIES menu to **00**=DISABLED.

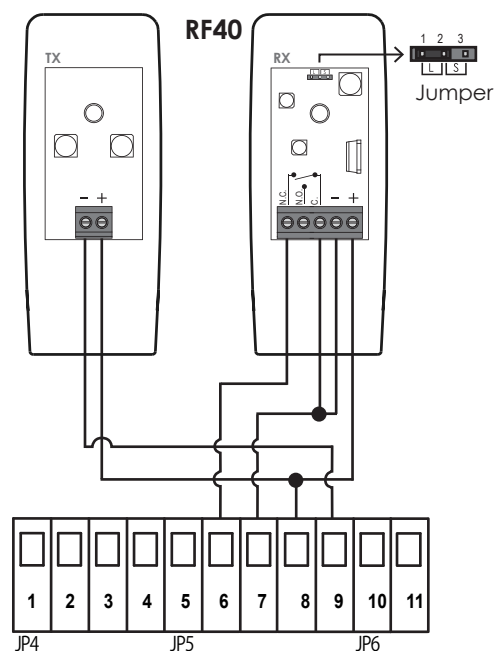

3.7 SAFETY EDGE wiring

3.7.1 CLOSING (Mechanical) Safety Edge

Wire the CLOSING SAFETY EDGE to terminals **5 - 9** on **JP5** terminal block.

- If the safety edge meet any obstacle while the gate is **CLOSING**, the automation **STOPS** and **REVERSES**.
- An obstacle detected by the safety edge while the gate is **OPENING** does not cause any effect.

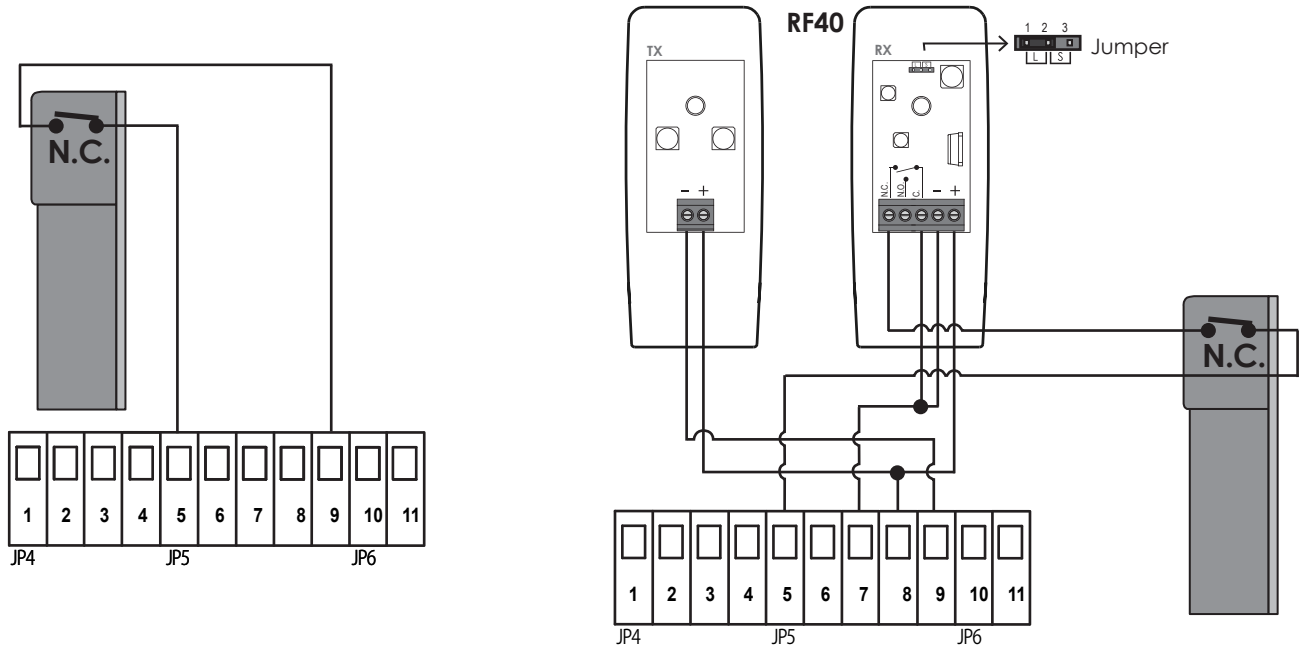

3.7.2 OPENING (Mechanical) Safety Edge

Wire the OPENING SAFETY EDGE to terminals **6 - 9** on **JP5** terminal block.

The opening safety edge will behave as follows:

- If the safety edge meet any obstacle while the gate is **OPENING**, the automation **STOPS** and **REVERSES** for about 10 cm.
- An obstacle detected by the safety edge while the gate is **CLOSING** does not cause any effect.

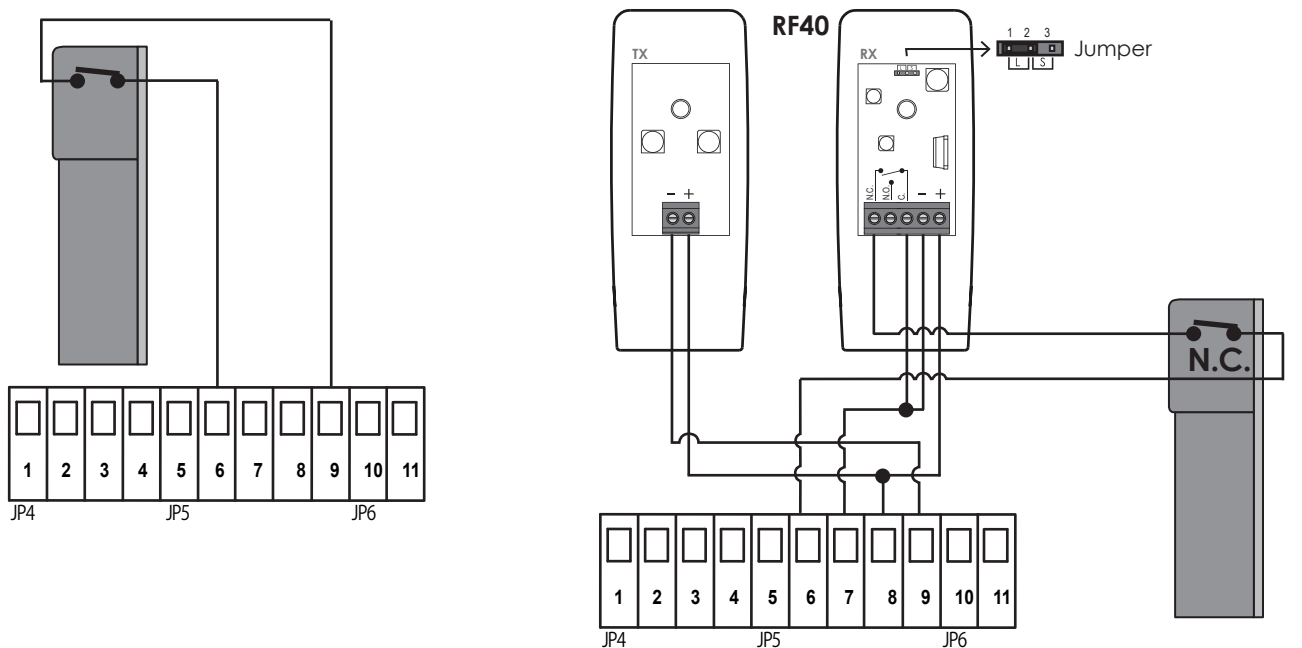

3.8 BLINKER wiring

You can wire a flashing light (20W max) to **10 - 11** terminals on **JP6** terminal block.

The flashing light will behave as follows:

- **QUICK** flashing → the gate is **OPENING**
- **SLOW** flashing → the gate is **CLOSING**
- **STILL** light on → the gate is in **PAUSE TIME** before the automatic closing

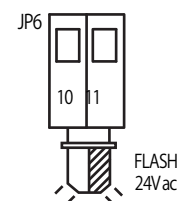

Note: You can select the kind of flashing light with **HL** parameter in the FUNCTIONS menu.

3.9 ELECTRIC-LOCK wiring

Plug the interface module **MEL04** (optional) into **J5** connector, please pay attention to the module's orientation as shown in the picture. Then wire the electric-lock to the **MEL04** terminals.

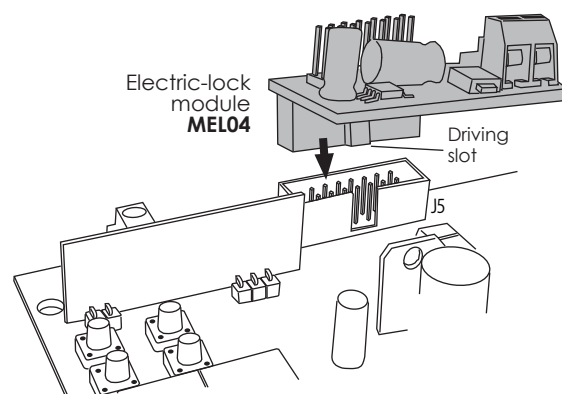
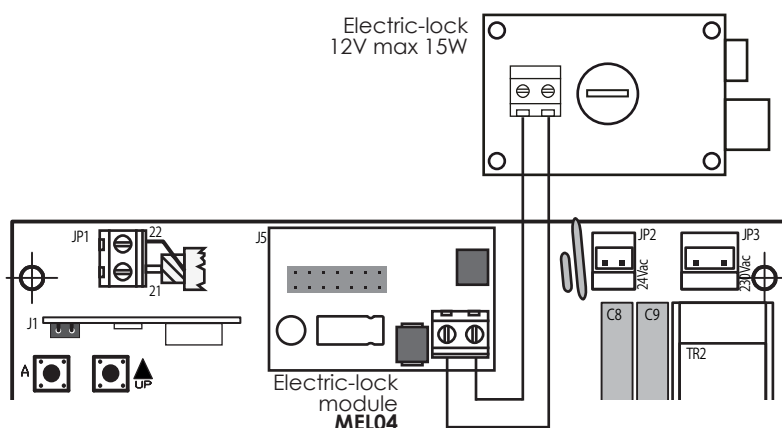

3.10 AUX/2ND RADIO CHANNEL module

Plug the additional **MRX01** module (optional) into **J5** connector, please pay attention to the module's orientation as shown in the picture.



Before setting the dip-switches **SW1** on the AUX module, make sure that the control panel is disconnected from any power supply.

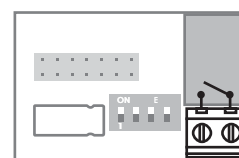
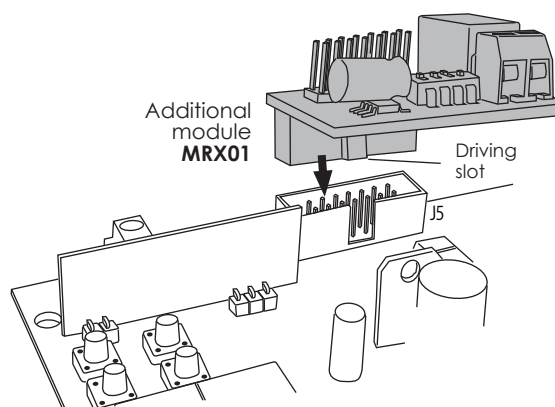
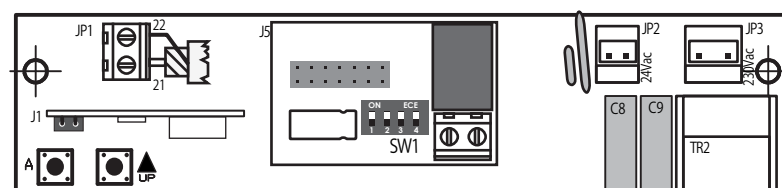

contact **N.O.**
max **1A - 24V**

3.10.1 2ND RADIO CHANNEL settings

Note: to use the MRX04 module as a 2nd radio channel, you need to save the corresponding radio code. Please refer to RADIO menu, parameter **A3**.

Select the AUX module settings with SW1 dip-switch-block:

STABLE switch

Electric contact closes every time you press the remote control.

To select this mode, please set the dip-switches on the module as shown:
1= ON 2= OFF 3= OFF Dip-switch 4 is non influential.



BISTABLE switch – Toggle Mode

Electric contact closes or opens every time you press the remote control.

To select this mode, please set the dip-switches on the module as shown:
1= OFF 2= ON 3= OFF Dip-switch 4 is non influential.

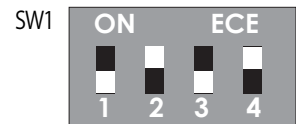

TIMER mode

Electric contact closes when you press the remote control and stays closed for 90 seconds.

To select this mode, please set the dip-switches on the module as shown:
1= ON 2= ON 3= OFF Dip-switch 4 is non influential.



3.10.2 CONTROL LIGHT settings

You can use the MRX01 module to control an indicator light. The electric contact stays closed, so the light stays on, during all the opening-closing cycle.

To select this mode, please set the dip-switches on the module as shown:
1= OFF 2= OFF 3= ON Dip-switch 4 is non influential.

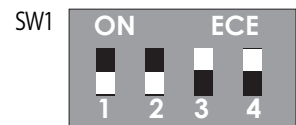

3.10.3 COURTESY LIGHT settings

You can also use the MRX01 module to control a courtesy light when the gate is operating. The electric contact closes since the gate starts operating till 90 seconds after the gates stops.

To select this mode, please set the dip-switches on the module as shown:
1= ON 2= OFF 3= ON Dip-switch 4 is non influential.



3.10.4 MAGNETIC LOCK mode

The contact remains permanently N.C., but it turns N.O one second before the gate starts OPENING and returns N.C. after fully CLOSING.

To select this mode, please set the dip-switches on the module as shown:
1= ON 2= ON 3= ON Dip-switch 4 is non influential.

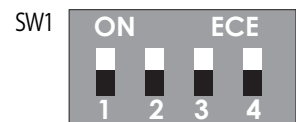



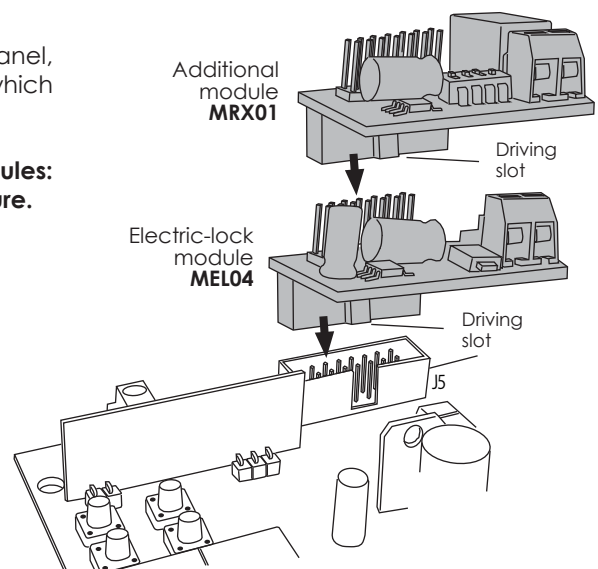

Note:

You can fit both the optional modules on the same control panel, placing them one on the top of the other as shown. No matter which one you put first.

But please pay attention carefully to the orientation of the modules: both reference slots facing the control panel shown as in the picture.



4. MAIN Menu

	Display	Description
A  ENTER	RR	RADIO menu
  SCROLL	CC	PROGRAMMING menu
A  CONFIRM	FF	FORCE menu
B  EXIT	HH	FUNCTIONS menu
	LL	TIMES menu
	PP	ACCESSORIES menu
	UU	UI Counter (number of cycles from 00.00.00 to 99.99.99)

4. PROGRAMMING

4.1 RR RADIO menu

This control panel can be used with standard fix code radio transmitters as well as with rollig-code radio transmitters. Transmitter's version must be chosen before starting any commissioning procedure. Once the first radio code has been stored into the receiver the control panel will work with such type of radio transmitter only (fix-code OR rolling code). Reset will not be possible.





You can store up to **64 different radio codes** on this control panel .

Press button A  and use   to select menu  





then press button A  to enter the RADIO menu: display will show

Use   buttons to scroll the lower level menu and select:







RI Saving a new remote control code – standard START command

1	Use   buttons to move inside the menu, till the display shows:	RI
2	Now press and hold the remote control and simultaneously press button A  on the control panel. The display shows the radio code position.	01 02 64 _(max)
3	If the display shows It means that memory is full and no further code can be stored.	FL
Repeat steps 1) and 2) to save another remote control as START command.		
4	Press button B  to go back to the top level menus, then press button B  again till the display shows: Or wait the timeout (20 seconds) to exit.	5d









A2 Saving a new remote control code – PEDESTRIAN START command

1	Use   buttons to move inside the menu, till the display shows:	A2
2	Now press and hold the remote control and simultaneously press button  on the control panel. The display shows the radio code position.	01 02 64 (max)
3	If the display shows It means that memory is full and no further code can be stored.	FL
Repeat steps 1) and 2) to save another remote control as PEDESTRAIN START command.		
4	Press button  to go back to the top level menus, then press button  again till the display shows:	5d
Or wait the timeout (20 seconds) to exit.		







A3 Saving a new radio code for the 2ND RADIO CHANNEL

 AUX optional radio module is needed to get a 2nd Radio Channel		
1	Use   buttons to move inside the menu, till the display shows:	A3
2	Now press and hold the remote control and simultaneously press button  on the control panel. The display shows the radio code position	01 02 64 (max)
3	If the display shows It means that memory is full and no further code can be stored.	FL
Repeat steps 1) and 2) to save another remote control for the 2ND RADIO CHANNEL		
4	Press button  to go back to the top level menus, then press button  again till the display shows:	5d
or wait the timeout (20 seconds) to exit		







A4 Deleting an existing remote control code

1	Use   buttons to move inside the menu, till the display shows:	A4
2	Press button  to confirm	
3	Use   buttons to select the position of the code you want to delete	01...0264
4	Press and hold button  for about 5 seconds till the display shows	5d
5	Release button  , control unit returns to stand-by	--
Repeat steps 1) to 5) to delete other existing remote control codes		
6	Press button  to go back to the top level menus, then press button  again till the display shows:	5d
or wait the timeout (20 seconds) to exit		

Deleting ALL stored radio codes

1	Use   buttons to move inside the menu, till the display shows:	A5
2	Press and hold button  for about 10 seconds till the display shows	Sd
3	Release button  , control unit returns to stand-by	--
4	Press button  to go back to the top level menus, then press button  again till the display shows: or wait the timeout (20 seconds) to exit	Sd

4.2 [] PROGRAMMING menu

Press button  and use   to select menu [] ,
then press button  to enter the PROGRAMMING menu: display will show [_
Use   buttons to scroll the lower level menu.



4.2.1 Selecting the PROGRAMMING MODE

[] AUTOMATIC programming mode, with OBSTACLE DETECTION

IMPORTANT:

Please check first that motors force (default setting level is 7 in a 1 to 10 range) is suitable to the leaves' weight.
In case of very light or very heavy gates please adjust **F1** and **F2** settings in **FF** FORCE menu accordingly before carry-out any programming procedure: the leave shouldn't stop if a light force is opposed.

- If possible is better to program the control unit when motors are cold (not after repeated use)
- The gate must have opening and closing ground stops for a correct AUTOMATIC programming procedure.

1	Use   buttons to move inside the menu, till the display shows:	[]
2	Press and hold button  for about 10 seconds . The control panel starts the automatic programming procedure, the gate will: <ul style="list-style-type: none"> • Open for 3-5 seconds (no matter if it was open, closed or mid-way) • Stop and reverse till the fully closed position • Perform a complete opening-closing cycle 	
3	Now working times, deceleration times and the level of sensibility for obstacle detection have been automatically set.	

If further adjustments of the sensibility level for obstacle detection are needed, please refer to settings **F3** and **F4** in the **FF** FORCE menu.

If **F1 and **F2** settings are changed once programming is completed, you need to re-start AUTOMATIC programming procedure again.**

NOTE:

In AUTOMATIC programming mode **C1**, working times of the motors (**L5** and **L6** settings) can't be changed.

This step-by-step programming procedure allows you full control of each setting and finer professional adjustments.



If the control panel is programmed using this procedure, **obstacle detection** function is automatically **disabled**.







IMPORTANT:

Please check first that motors force (default setting level is 7 in a 1 to 10 range) is suitable to the leaves' weight.

In case of very light or very heavy gates please adjust $F1$ and $F2$ settings in FF FORCE menu accordingly before carry-out any programming procedure: the leave shouldn't stop if a light force is opposed.

- If possible is better to program the control unit when motors are cold (not after repeated use)
- The gate must have opening and closing ground stops for a correct SEQUENTIAL programming procedure.





You can program the control panel with the sequential procedure using button  on the control panel or using a remote control previously saved.





1	Use   buttons to move inside the menu, till the display shows:	C2
2	Press button  to confirm. The display shows:	n1
3	Press the remote control (or button  on the control panel). <ul style="list-style-type: none"> • Leaf 1 starts opening. 	
4	When Leaf 1 is about to 90% of the opening path, press again the remote control (or button  on the control panel). <ul style="list-style-type: none"> • Leaf one decelerates and continues opening. 	
5	Once Leaf 1 has reached the fully open position, wait 4 - 5 seconds and then press again the remote control (or button ). The working parameters for Leaf 1 have been set. The display now shows:	n2
6	Repeat steps 3, 4, 5 of this procedure to set working times for Leaf 2 too.	
7	Now working times, deceleration times and the level of sensibility for obstacle detection have been automatically set.	





If $F1$ and $F2$ settings are changed once programming is completed, you need to re-start AUTOMATIC programming procedure again.

4.2.2 Restoring DEFAULT SETTINGS

The control panel comes with pre-set working parameters according to the automation model used. You can reset the control panel to the default settings as follows:

[3] RAM opener default settings		
1	Use   buttons to move inside the menu, till the display shows:	[3]
2	Press and hold button  for about 5 seconds .	
3	Press button  to go back to the top level menus, then press button  again till the display shows:	5 d
or wait the timeout (20 seconds) to exit.		



[4] ARTICULATED ARM opener default settings		
1	Use   buttons to move inside the menu, till the display shows:	[4]
2	Press and hold button  for about 5 seconds .	
3	Press button  to go back to the top level menus, then press button  again till the display shows:	5 d
or wait the timeout (20 seconds) to exit.		

[5] WHEEL-DRIVEN opener default settings		
1	Use   buttons to move inside the menu, till the display shows:	[5]
2	Press and hold button  for about 5 seconds .	
3	Press button  to go back to the top level menus, then press button  again till the display shows:	5 d
or wait the timeout (20 seconds) to exit.		







4.3 FF FORCE menu

Use this menu to adjust the **sensibility level of the obstacle detection** in case of AUTOMATIC Programming mode (**C1**)
or to adjust the **motors force** in case of SEQUENTIAL Programming mode (**C2**).







Press button **A**  and use   to select menu **FF**,
 then press button **A**  to enter the FORCE menu: display will show **F_**

Use   buttons to scroll the lower level menus:







F1 TORQUE/POWER adjustment - MOTOR 1

1	Use   buttons to move inside the menu, till the display shows:	F1
2	Press button A  to confirm. The display now shows the current torque/power level for Motor 1:	01 02 (min) 10
3	Use   buttons to change the Motor 1 torque/power level.	(max)
4	Press button B  to go back to the top level menus, then press button B  again till the display shows: or wait the timeout (20 seconds) to exit.	Sd







F2 TORQUE/POWER adjustment - MOTOR 2

1	Use   buttons to move inside the menu, till the display shows:	F2
2	Press button A  to confirm. The display now shows the current torque/power level for Motor 2:	01 02 (min) 10
3	Use   buttons to change the Motor 2 torque/power level.	(max)
4	Press button B  to go back to the top level menus, then press button B  again till the display shows: or wait the timeout (20 seconds) to exit.	Sd

F 3 OBSTACLE DETECTION adjustment - MOTOR 1

1	Use   buttons to move inside the menu, till the display shows:	F 3
2	Press button  to confirm. The display now shows the current sensibility level for the obstacle detection of Motor 1:	00 (OFF) 01 (min) 10 (max)
3	Use   buttons to change the Motor 1 sensibility level	
4	Press button  to go back to the top level menus, then press button  again till the display shows: or wait the timeout (20 seconds) to exit.	S d

F 4 OBSTACLE DETECTION adjustment - MOTOR 2

1	Use   buttons to move inside the menu, till the display shows:	F 4
2	Press button  to confirm. The display now shows the current sensibility level for the obstacle detection of Motor 2:	00 (OFF) 01 (min) 10 (max)
3	Use   buttons to change the Motor 2 sensibility level.	
4	Press button  to go back to the top level menus, then press button  again till the display shows: or wait the timeout (20 seconds) to exit.	S d

N.B.:

NOTE: If OBSTACLE DETECTION is too sensitive, causing unexpected stops or reversal of leaves, you need to re-adjust F 3 and F 4 settings to a lower level.

4.4 HH FUNCTIONS menu

Use this menu to enable/disable special settings.

1 = function is **ON**

0 = function is **OFF**







Press button A  and use   to select menu **HH**.

then press button A  to enter the FUNCTIONS menu: display will show **H _**

Use   buttons to scroll the lower level menus:







H1 MULTI-OCCUPATION Function

This function grants **priority to the opening command**; when two people activate the gate at the same time the first opening command prevails, while opening the control panel ignores any further command.

1	Use   buttons to move inside the menu, till the display shows:	H1
2	Press button A  to confirm.	
3	Use   buttons to select: MULTI-OCCUPATION Function OFF MULTI-OCCUPATION Function ON	00 01
4	Press button B  to go back to the top level menus, then press button B  again till the display shows: or wait the timeout (20 seconds) to exit.	Sd

H2 PRE-BLINKING Function







This function makes the flashing light **pre-blinking** for **4-5 seconds** before the gate starts opening.

1	Use   buttons to move inside the menu, till the display shows:	H2
2	Press button A  to confirm.	
3	Use   buttons to select: PRE-BLINKING Function OFF PRE-BLINKING Function ON	00 01
4	Press button B  to go back to the top level menus, then press button B  again till the display shows: or wait the timeout (20 seconds) to exit.	Sd

H3

DECELERATION Function







This function decelerates the leaves at the end of the opening/closing cycle.

1	Use   buttons to move inside the menu, till the display shows:	H3
2	Press button  to confirm.	
3	Use   buttons to select: DECELERATION Function OFF DECELERATION Function ON	00 01
4	Press button  to go back to the top level menus, then press button  again till the display shows: or wait the timeout (20 seconds) to exit.	Sd

H4

PHOTOCELLS TEST Function

If this function is enabled, the control panel performs a quick start-up test with the photocells to make sure that they are in operation.

1	Use   buttons to move inside the menu, till the display shows:	H4
2	Press button  to confirm.	
3	Use   buttons to select: PHOTOCELLS TEST Function OFF PHOTOCELLS TEST Function ON	00 01
4	Press button  to go back to the top level menus, then press button  again till the display shows: or wait the timeout (20 seconds) to exit.	Sd







H5

REVERSING STROKE Function



For use with ELECTRIC-LOCK and **MEL04** optional module only.

This setting makes the motors push in opposite direction for **1 second** to help release the electro-lock if the pins are tight in the striker plate.

1	Use   buttons to move inside the menu, till the display shows:	H5
2	Press button  to confirm.	
3	Use   buttons to select: REVERSING STROKE Function OFF REVERSING STROKE Function ON	00 01
4	Press button  to go back to the top level menus, then press button  again till the display shows: or wait the timeout (20 seconds) to exit.	Sd

H 6

LOCK PULSE Function



For use with ELECTRIC-LOCK and **MEL04** optional module only.

This setting makes the motors operate full power for **1 second** when they are near to closing to ensure lock returns to its striker plate.

1	Use buttons to move inside the menu, till the display shows:	H 6
2	Press button to confirm.	
3	Use buttons to select:	LOCK PULSE Function OFF LOCK PULSE Function ON
		00 01
4	Press button to go back to the top level menus, then press button again till the display shows:	S d
	or wait the timeout (20 seconds) to exit.	

H 7

START-UP /SOFT START

When starting an opening cycle the control unit gives full power to both motors for **1.5 seconds** in order to overcome the gate's inertia (due to cold weather or long time inactivity).

If SOFT START is on the control unit gives full power to the motors gradually to prevent the gate from flapping/salmming

1	Use buttons to move inside the menu, till the display shows:	H 7
2	Press button to confirm.	
3	Use buttons to select:	START PULSE Function OFF START PULSE Function ON SOFT START Function ON
		00 01 02
4	Press button to go back to the top level menus, then press button again till the display shows:	S d
	or wait the timeout (20 seconds) to exit.	

H 8

QUICK CLOSING Function

Quick closing after the car has gone through the photocells beam: the gate will complete opening and close immediately after the car without waiting for the entire pause time to elapse.

If another car arrives in the meanwhile, the gate will wait the standard pause time before closing.

1	Use buttons to move inside the menu, till the display shows:	H 8
2	Press button to confirm.	
3	Use buttons to select:	QUICK CLOSING Function OFF QUICK CLOSING Function ON
		00 01
4	Press button to go back to the top level menus, then press button again till the display shows:	S d
	or wait the timeout (20 seconds) to exit.	

H9

SINGLE LEAF Function



Enable this setting in case of a **single-leaf swing gate**.

1	Use buttons to move inside the menu, till the display shows:	H9
2	Press button to confirm.	
3	Use buttons to select:	SINGLE LEAF Function OFF SINGLE LEAF Function ON
		00 01
4	Press button to go back to the top level menus, then press button again till the display shows:	5d
	or wait the timeout (20 seconds) to exit.	

HA

SEPARATE PUSH-BUTTONS Function

This allows to use to different push-buttons/controls for opening and closing.

To use this function, you need to wire:

- opening push-button/control to **START** terminals
- closing push-button/control to **PEDESTRIAN START** terminals

1	Use buttons to move inside the menu, till the display shows:	HA
2	Press button to confirm.	
3	Use buttons to select:	SEPARATE PUSH-BUTTONS Function OFF SEPARATE PUSH-BUTTONS Function ON
		00 01
4	Press button to go back to the top level menus, then press button again till the display shows:	5d
	or wait the timeout (20 seconds) to exit.	

HC

MOTORS TEST Function

If this function is enabled, the control panel performs a quick start-up test with the motors to make sure that they are in operation.

1	Use buttons to move inside the menu, till the display shows:	HC
2	Press button to confirm.	
3	Use buttons to select:	MOTORS TEST Function OFF MOTORS TEST Function ON
		00 01
4	Press button to go back to the top level menus, then press button again till the display shows:	5d
	or wait the timeout (20 seconds) to exit.	

HE FINAL MOTOR RELEASE in CLOSING – Motor 1 only**Use only with the AUTOMATIC Programming mode - [I**This setting makes **motor 1** to release the push a little bit once the gate is fully closed.

1	Use buttons to move inside the menu, till the display shows:	HE
2	Press button A to confirm.	
3	Use buttons to select the level of the FINAL MOTOR 1 RELEASE when CLOSING:	00 (OFF) 01 (min) ... 10 (max)
4	Press button B to go back to the top level menus, then press button B again till the display shows: or wait the timeout (20 seconds) to exit.	5d

HF FINAL MOTORS RELEASE in OPENING – Motor 1 and 2**Use only with the AUTOMATIC Programming mode - [I**This setting allows **both motor** to release a little bit the push once the gate is fully **open**.

1	Use buttons to move inside the menu, till the display shows:	HF
2	Press button A to confirm.	
3	Use buttons to select the level of the FINAL MOTORS RELEASE when OPENING:	00 (OFF) 01 (min) ... 10 (max)
4	Press button B to go back to the top level menus, then press button B again till the display shows: or wait the timeout (20 seconds) to exit.	5d







HL FLASHING LIGHT mode selection

Use this settings to select the signal mode of the falshing light according to the blinker model you have.

1	Use buttons to move inside the menu, till the display shows:	HL
2	Press button A to confirm	
3	Use buttons to select: BLINKING signal (Standard Flashing Light) FIX signal (LED Flashing Light)	00 01
4	Press button B to go back to the top level menus, then press button B again till the display shows: or wait the timeout (20 seconds) to exit.	5d







4.5 L L TIMES menu

Use this menu to adjust motors **operating time** and **pause time** before automatic closing.

Press button A  and use   to select menu LL,
then press button A  to enter the TIMES menu: display will show L _
Use   buttons to scroll the lower level menus:







L1 OPENING DELAY between leaves

Use this setting to adjust delay time between leaves when opening (from **1 to 10 seconds**).

1	Use   buttons to move inside the menu, till the display shows:	LL
2	Press button A  to confirm.	
3	Use   buttons to set the delay time between opening leaves:	00 (OFF) 01 ... 10 (max)
4	Press button B  to go back to the top level menus, then press button B  again till the display shows: or wait the timeout (20 seconds) to exit.	5d







L2 CLOSING DELAY between leaves

Use this setting to adjust delay time between leaves when closing (from **1 to 20 seconds**).

1	Use   buttons to move inside the menu, till the display shows:	L2
2	Press button A  to confirm	
3	Use   buttons to set the delay time between closing leaves:	00 (OFF) 01 ... 20 (max)
4	Press button B  to go back to the top level menus, then press button B  again till the display shows: or wait the timeout (20 seconds) to exit.	5d







L 3 AUTOMATIC CLOSING Pause time

Use this menu set the pause time for the Automatic Closing (from 0 to 99 seconds).

1	Use   buttons to move inside the menu, till the display shows:	L 3
2	Press button  to confirm.	
3	Use   buttons to set the pause time for automatic closing:	00 (OFF) 01 ... 99 (max)
4	Press button  to go back to the top level menus, then press button  again till the display shows: or wait the timeout (20 seconds) to exit.	5d

L 4 PEDESTRIAN AUTOMATIC CLOSING Pause time

Use this menu set the pause time for the Pedestrian Automatic Closing (from 0 to 99 seconds).

1	Use   buttons to move inside the menu, till the display shows:	L 4
2	Press button  to confirm.	
3	Use   buttons to set the pause time for Pedestrian automatic closing:	00 (OFF) 01 ... 99 (max)
4	Press button  to go back to the top level menus, then press button  again till the display shows: or wait the timeout (20 seconds) to exit.	5d







L 5 OPERATING TIME – Motor 1

Use this menu to adjust **Motor 1 opening/closing**.



Use only with the SEQUENTIAL Programming mode - **C 2**

In AUTOMATIC programming mode **C 1**, working time of MOTOR 1 can't be changed

1	Use   buttons to move inside the menu, till the display shows:	L 5
2	Press button  to confirm.	
3	Use   buttons to reduce/increase Motor 1 operating time:	01 ... 99 (max)
4	Press button  to go back to the top level menus, then press button  again till the display shows: or wait the timeout (20 seconds) to exit.	5d

L6

OPERATING TIME – Motor 2

Use this menu to adjust **Motor 1 opening/closing**.



Use only with the **SEQUENTIAL Programming mode** [2].

In **AUTOMATIC programming mode** [1] working time of **MOTOR 2** can't be changed.

1	Use buttons to move inside the menu, till the display shows:	L6
2	Press button A to confirm.	
3	Use buttons to reduce/increase Motor 2 operating time:	01 (max) ... 99
4	Press button B to go back to the top level menus, then press button B again till the display shows:	5d
or wait the timeout (20 seconds) to exit.		

L7

DECELERATION TIME – Motor 1

Use this setting to adjust opening/closing deceleration time for **Motor 1** (from 1 to 10 seconds)

Before adjusting this setting, please make sure that parameter **H3** in **HH** FUNCTIONS menu is:







H3 = 1 Deceleration ON

1	Use buttons to move inside the menu, till the display shows:	L7
2	Press button A to confirm.	
3	Use buttons to reduce/increase Motor 1 deceleration time:	00 (OFF) 01 (min) ... 10 (max)
4	Press button B to go back to the top level menus, then press button B again till the display shows:	5d
or wait the timeout (20 seconds) to exit.		

L 8 DECELERATION TIME - Motor 2







Use this setting to adjust opening/closing deceleration time for **Motor 2** (from 1 to 10 seconds).

Before adjusting this setting, please make sure that parameter **H3** in **HH** FUNCTIONS menu is:
H3 = 1 Deceleration ON

1	Use   buttons to move inside the menu, till the display shows::	
2	Press button A  to confirm.	L8
3	Use   buttons to reduce/increase Motor 2 deceleration time:	00 (OFF) 01 (min) ... 10 (max)
4	Press button B  to go back to the top level menus, then press button B  again till the display shows:	5d
	or wait the timeout (20 seconds) to exit.	

L 9 PEDESTRIAN OPENING TIME

Use this setting to adjust operating time for **Pedestrian Opening for Motor 1** (from 1 to 12 seconds).







1	Use   buttons to move inside the menu, till the display shows:	L9
2	Press button A  to confirm.	
3	Use   buttons to set Motor 1 Pedestrian opening time:	00 (total opening) 01 (min) ... 12 (max)
4	Press button B  to go back to the top level menus, then press button B  again till the display shows:	5d
	or wait the timeout (20 seconds) to exit.	

4.6 PP ACCESSORIES menu







Use this menu to manage terminals for wiring the accessories (**controls and safety devices**).

Press button **A**  and use   to select menu **PP**,
then press button **A**  to enter the ACCESSORIES menu: display will show **P_**
Use   buttons to scroll the lower level menus:







P1 EMERGENCY STOP terminals

1	Use   buttons to move inside the menu, till the display shows:	P1
2	Press button A  to confirm.	
3	Use   buttons to select: STOP Push-button - NOT WIRED STOP Push-button - WIRED	00 01
4	Press button B  to go back to the top level menus, then press button B  again till the display shows: or wait the timeout (20 seconds) to exit.	Sd

P2 CLOSING PHOTOCELLS terminals







1	Use   buttons to move inside the menu, till the display shows:	P2
2	Press button A  to confirm.	
3	Use   buttons to select: CLOSING Photocells - NOT WIRED CLOSING Photocells - WIRED	00 01
4	Press button B  to go back to the top level menus, then press button B  again till the display shows: or wait the timeout (20 seconds) to exit.	Sd

P3 OPENING PHOTOCELLS / SAFETY EDGE terminals





1	Use   buttons to move inside the menu, till the display shows:	P3
2	Press button A  to confirm.	
3	Usare i tasti   per selezionare: Opening Photocells/Safety Edges - NOT WIRED Opening Photocells - WIRED Standard Safety Edge (NC contact) - WIRED 8K2 Safety Edge - WIRED	00 01 02 03
If a 8K2 safety edge is wired (P3 = 03), when detecting an obstacle the gate will STOP and:		
<ul style="list-style-type: none"> • Reverse for about 10 cm when opening • Reverse and open fully when closing 		
4	Press button B  to go back to the top level menus, then press button B  again till the display shows: or wait the timeout (20 seconds) to exit.	Sd

4.7 UU CYCLE COUNTING menu

You can use this function to check how many complete cycles (opening-closing) the system has performed from first installation.

Press button **A**  and use   to select menu **UU**,
 then press button **A**  to enter the CYCLE COUNTING menu: display will show **U_**.
 Use   buttons to scroll the lower level menus:

U1 EMERGENCY STOP terminals

1	Use   buttons to move inside the menu, till the display shows:	U1
2	Press button A  to confirm. The display shows the number of complete opening and closing cycles of the gate.	
4	Press button B  to go back to the top level menus, then press button B  again till the display shows:	Sd
	or wait the timeout (20 seconds) to exit.	

5. TROUBLE-SHOOTING

Display	Issue	Possible Reasons	Solutions
88	DISPLAY OFF	Power-cut	Check main power supply
		Burnt fuses	Replace the fuses
		Transformer problem	Check all connections and input/output voltage
FC	CLOSING PHOTOCELLS	Misalignment of the photocells	Check transmitter and receiver position/alignment
		Obstacle disturbing the photocells beam	Check and remove the obstacle. Also check the photocells eye and remove any dust or dirty deposit.
		Incorrect wiring	Check all electrical wirings following the diagram
		Photocell not powered	Check power and voltage both on receiving and transmitting photocell
		Closing photocells not wired	Wire the photocells or disabled corresponding parameter (please refer to paragraph 3.6.1)
FA	OPENING PHOTOCELLS	Misalignment of the photocells	Check transmitter and receiver position/alignment
		Obstacle disturbing the photocells beam	Check and remove the obstacle. Also check the photocells eye and remove any dust or dirty deposit
		Incorrect wiring	Check all electrical wirings following the diagram
		Photocell not powered	Check power and voltage both on receiving and transmitting photocell
		Opening photocells not wired	Wire the photocells or disable corresponding parameter (please refer to paragraph 3.6.2)
FE	PHOTOCELLS TEST FAILED	Incorrect wiring	Check all electrical wirings following the diagram
		Unfitting photocells	Please install original photocells
SP	EMERGENCY STOP	Incorrect wiring	Check all electrical wirings following the diagram (paragraph 3.5)
		Emergency STOP push-button not wired	Wire the STOP push-button or disable corresponding parameter (please see paragraph 3.5)
St	START COMMAND	The control panel is receiving a continuous START command	Make sure that all START controls connect are properly working and correctly wired (N.O. contact)
Pd	PEDESTRIAN START COMMAND	The control panel is receiving a continuous PEDESTRIAN START command	Make sure that all PEDESTRIAN START controls connect are properly working and correctly wired (N.O. contact)
nE	MOTORS TEST FAILED	Motors not wired	Wire the motors as shown in the diagram
		Incorrect wiring	Check motors electrical wiring (please see paragraph 3.3)
		Electrical coil broken	Use a tester to check the coil status
01 02 50 64	RADIO	The control panel is continuously receiving a radio command	Check all keys of the remote controls. Make sure that there is no stuck key (led on the remote control always on). If needed remove the battery from the remote control and check that the error message disappears from the display

6. BOX Installation

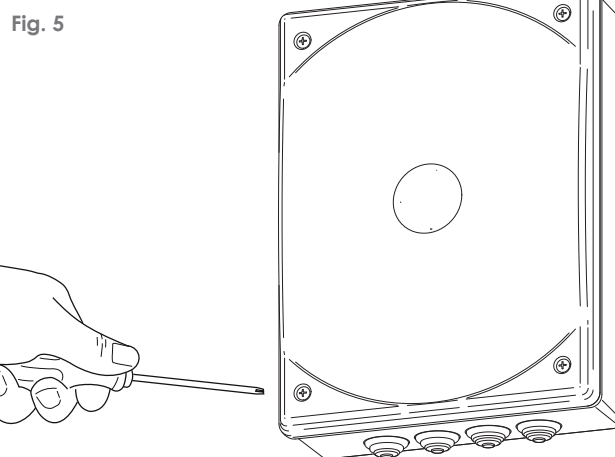
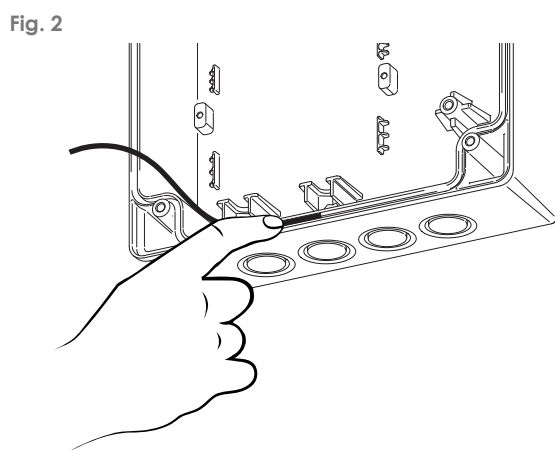
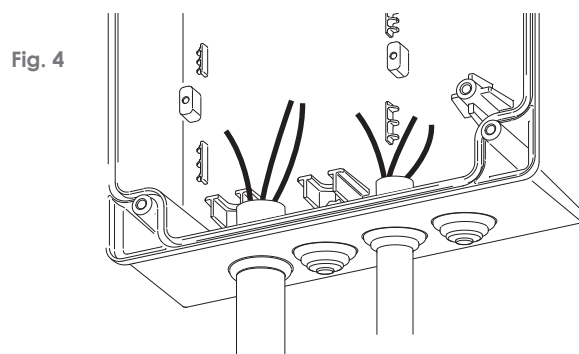
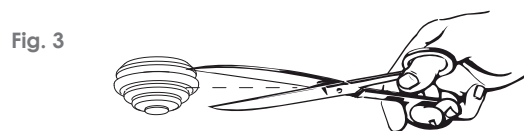
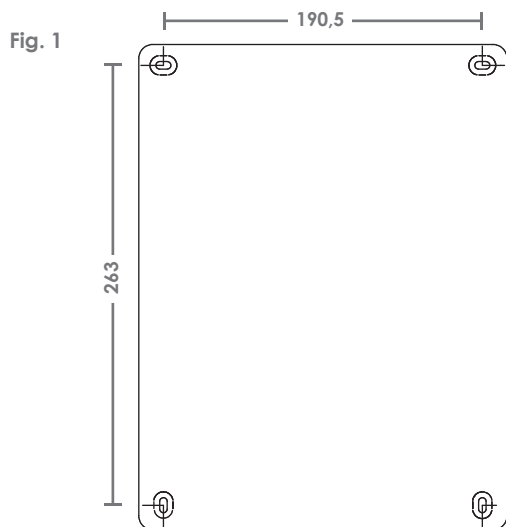

- 1) Choose the place for the box and mark the fixing points on the wall. Pay attention to respect the distances between the holes (fig. 1).
- 2) Make the drillings and fix the box with the pre-drilled holes downwards.
- 3) Slip the washer round the edge of the box, starting from centre down (fig. 2). Do not extend the washer, just push it into its housing and cut any excess.
- 4) Cut the rubber grommets the same size of the wires/cables for electrical wirings (fig. 3) so that the grommet perfectly adheres to the cable/wire. Do not cut the rubber grommets you're not going to use.
- 5) Put all the grommets in the pre-drilled holes of the box and drive the cables/wires (fig. 4).
- 6) Once wirings and installation are finished close the box and screw the cover on the box (fig. 5).

7. DISPOSAL



Do not pollute the environment

Some electronic components may contain polluting substances. Ensure materials are passed to the authorised collection centres, according to the laws and the regulations on force, for safe disposal.



= DEFAULT Settings

AA RADIO Menu

A1	SAVING a new remote control – START command	01.....64 (max) FL = memory is full
A2	SAVING a new remote control – PEDESTRIAN START command	01.....64 (max) FL = memory is full
A3	SAVING a new remote control – 2° RADIO CHANNEL <i>With optional AUX module only</i>	01.....64 (max) FL = memory is full
A4	DELETING an existing remote control code	01.....64
A5	DELETING ALL stored remote controls	

CC PROGRAMMING Menu

C1	AUTOMATIC Programming Procedure with OBSTACLE DETECTION	
C2	SEQUENTIAL Programming Procedure	
C3	Reset to Default Settings for RAM openers	
C4	Reset to Default Settings for ARTICULED ARM openers	
C5	Reset to Default Settings for WHEEL-DRIVEN openers	

FF FORCE Menu

F1	TORQUE/POWER adjustment - Motor 1	
F2	TORQUE/POWER adjustment - Motor 2	
F3	OBSTACLE DETECTION level adjustment - Motor 1 With C1 AUTOMATIC Programming procedure only	
F4	OBSTACLE DETECTION level adjustment - Motor 2 With C1 AUTOMATIC Programming procedure only	

HH SPECIAL FUNCTIONS Menu

H1	MULTI-OCCUPATION Function	00 = OFF 01 = ON
H2	PRE-BLINKING Function	00 = OFF 01 = ON
H3	DECELERATION Function	00 = OFF 01 = ON
H4	PHOTOCELLS TEST Function	00 = OFF 01 = ON
H5	REVERSING STROKE Function <i>With electric lock and MEL04 module only</i>	00 = OFF 01 = ON
H6	LOCK PULSE Function <i>With electric lock and MEL04 module only</i>	00 = OFF 01 = ON
H7	START PULSE Function	00 = OFF 01 = ON
	SOFT-START Function	02 = SOFT START
H8	QUICK CLOSING Function	00 = OFF 01 = ON
H9	SINGLE LEAF Function	00 = OFF 01 = ON
HA	SEPARATE PUSH-BUTTONS Function	00 = OFF 01 = ON
HC	MOTORS TEST Function	00 = OFF 01 = ON
HE	FINAL RELEASE in CLOSING – Motor 1 C1 Program. procedure only	00 = OFF 00...10 (max)
HF	FINAL RELEASE in OPENING – Motors 1 and 2 C1 Program. procedure only	00 = OFF 00...10 (max)
HL	FLASHING LIGHT mode	00 = flashing 01 = FIX (LED)

CE COMPLIANCE DECLARATION

Manufacturer: **PROTECO S.r.l.**

Address: Via Neive, 77 – 12050 Castagnito (CN) – ITALIA

declares that

The product type: **Q80A** electronic controller for gate automation (1 or 2 motors), 230V

Models: PQ80A, PQ80AD

Accessories: MEL04, MRX01

Is built to be integrated into a machine or to be assembled with other machinery to create a machine under provisions of 2006/42/EC Machinery Directive.

It complies with the essential requirements of EEC Directives:

2006/95/CE Directive Basse Tension

2004/108/CE Directive Compatibilité Electromagnétique

2014/53/UE (RED)

The manufacturer declares that the start-up of the machinery is not permitted unless the machine, in which the product is incorporated or of which is becoming a component, has been identified and declared as conformed to 2006/42/EC Machinery Directive.

Note: These products have undergone test in a typical uniform configuration

Castagnito, January 17th 2018

Marco Gallo
Managing Director

